

# CARD LOCKS

— EUROPEAN / ANSI STANDARD



## Slim Simplified Design



Contactless technology



**929VSS-D**  
Stainless steel

- 304 Stainless steel
- Applicable with European standard mortise or ANSI mortise
- Replace old mechanical lock easily, No need to change old mortise or old door
- Detect card mode: advanced Micro Wave
- Hidden cylinder cover
- Can work with software or without software (should specify when give order)
- Suitable for Hotel, Commercial office, School, Government, Hospital, Marine, Residence.
- Axis distance from handle centre to cylinder can be 92.5mm, 72mm, 85mm

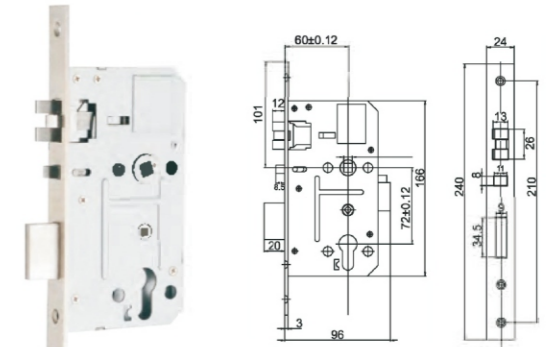

Optional mortise 6#

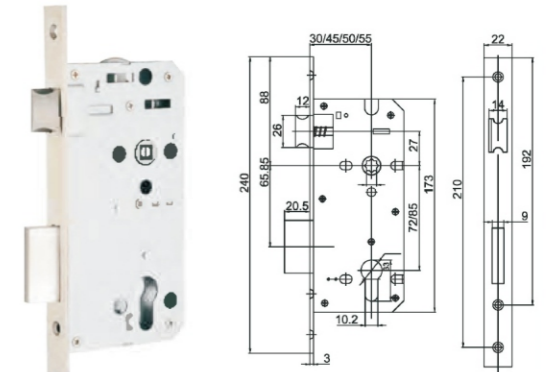

Standard mortise 6085/6072 panic release

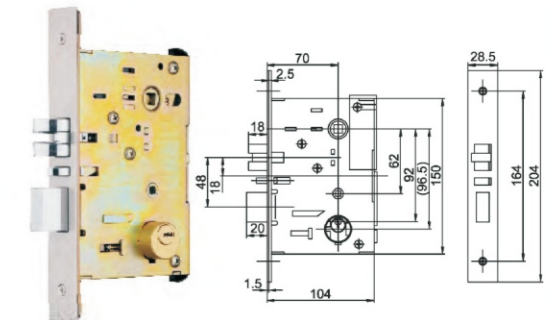

Optional mortise ANSI



**929VTW-D**  
Stainless steel

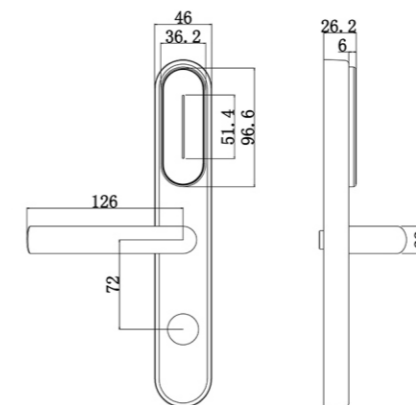

Applicable card:	Mifare 1, Desfire Optional, Bluetooth Optional
Material:	Stainless steel 304
Mechanical key override:	Yes
Battery:	4 standard AAA alkaline batteries, 18 months in normal state
Indication:	Light, Sound (Mute, Beep, or music optional)
Deadbolt Indication:	Blue and red light when touch key card
Unlocking record for trail:	Yes
Low voltage warning:	Yes
Passage mode for meeting room:	Yes
Static consumption:	12uA
Dynamic consumption:	300mA
Humidity:	20%~80%
Working temperature:	-10°C~60°C
Handle optional:	None
Packing:	8PCS/CTN 22KGS/CTN 68*35*27CM/CTN

# CARD LOCKS

— EUROPEAN / ANSI STANDARD

Slim fashionable design, modern European style



Contactless technology



**929SS-8-D**  
Stainless steel

- 304 Stainless steel
- Applicable with European standard mortise. Or ANSI mortise
- Replace old mechanical lock easily, No need to change old mortise or old door
- Axis distance from handle centre to cylinder can be 70mm, 72mm, 85mm
- Detect card mode: advanced Micro Wave
- Hidden cylinder cover or cylinder bare optional
- Can work with software or without software (should specify when give order)
- Suitable for Hotel, Commercial office, School, Government, Hospital, Marine, Residence.

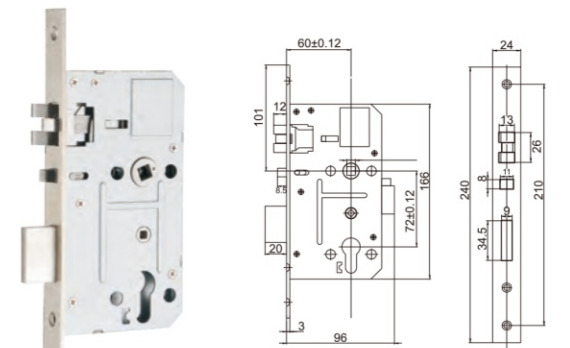

Optional mortise 6#

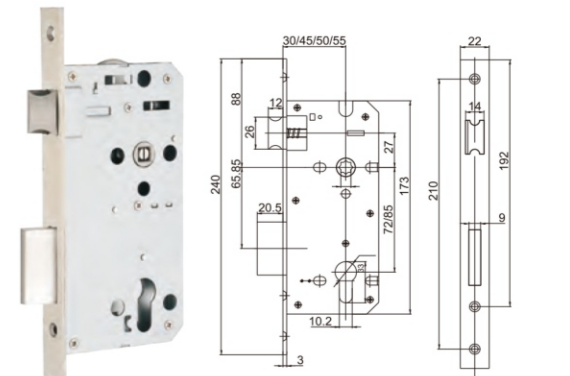

Standard mortise 6085/6072 panic release

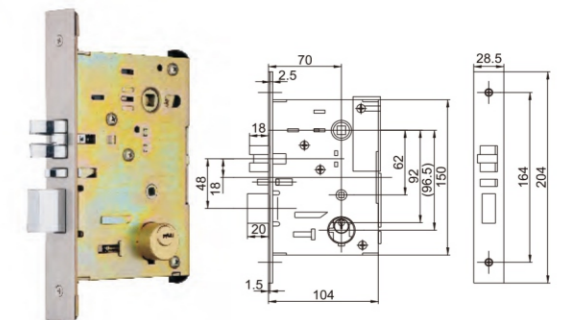

Optional mortise ANSI

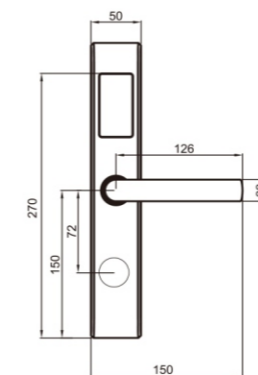

Applicable card:	Mifare 1, Desfire Optional, Bluetooth Optional
Material:	Stainless steel 304
Mechanical key override:	Yes
Battery:	4 standard AAA alkaline batteries, 18 months in normal state
Indication:	Light, Sound (Mute, Beep, or music optional)
Deadbolt Indication:	Blue and red light when touch key card
Unlocking record for trail:	Yes
Low voltage warning:	Yes
Passage mode for meeting room:	Yes
Static consumption:	12uA
Dynamic consumption:	300mA
Humidity:	20%-80%
Working temperature:	-10°C~60°C
Handle optional:	C Handle, E Handle, or Client specified
Packing:	6PCS/CTN, 18KGS/CTN, 38*36*37CM